

dualchef

DUAL BASKET AIR FRYER

INSTRUCTION MANUAL

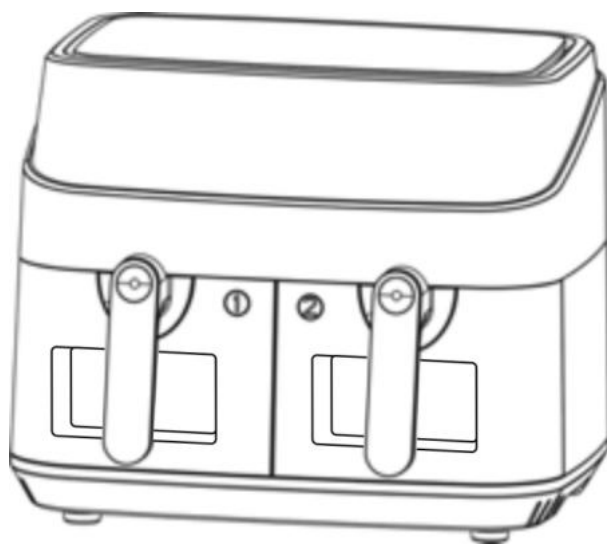

DUAL BASKET AIR FRYER
TT-DAF6W



Thank you for buying **dualchef** - dual basket air fryer by **TurboTronic®**. You will now be able to cook a wide assortment of food in a healthier manner – with little or no oil!

The air fryer uses hot air, in combination with high-speed air circulation, and a top grill to prepare your dishes quickly and easily. The ingredients are heated from all sides, at once, and there is no need to add oil in most cases.

IMPORTANT SAFEGUARDS

HOUSEHOLD USE ONLY. READ ALL INSTRUCTIONS.

When using electrical appliance, basic safety precautions should always be followed, including the following:

Read this user manual carefully, before you use the appliance, and keep it safely for future reference.

⚠ WARNINGS

- **Never** immerse the housing, which contains electrical components and the heating elements, in water nor rinse it under the tap.
- **Do not** let any water or other liquid enter the appliance – to prevent electric shock.
- Always put the ingredients to be fried in the basket, to prevent it from coming into contact with the heating elements.
- **Do not** cover the air inlet and the air exhaust openings while the appliance is operating.
- **Do not** fill the frying tray with oil as this may cause a fire hazard.
- **Never** touch the inside of the appliance while it is operating.
- Check whether the voltage indicated on the appliance corresponds to the local mains voltage in your country before you connect the appliance.
- **Do not** use the appliance if the plug, the power cord or the appliance itself is damaged.
- If the power cord is damaged, you must have it replaced at a service center authorized by similarly qualified persons in order to avoid a hazard.
- This appliance is not suitable for children or for people who are either physically or mentally handicapped or who lack experience and knowledge. Should you want anyone else to use the appliance, that person should be



- properly guided on its use.
- Keep the appliance and its mains cord out of the reach of children when the appliance is switched on or is cooling down.
 - Keep the mains cord away from hot surfaces.
 - **Do not** plug in the appliance or operate the control panel with wet hands.
 - Only connect the appliance to an earthed wall socket. Always make sure that the plug is inserted into the wall socket properly.
 - **Never** connect this appliance to an external timer switch.
 - **Do not** place the appliance on or near combustible materials such as a tablecloth or curtains.
 - **Do not** place the appliance against a wall or against other appliances. Leave at least 10cm free space at the back and sides and 10cm free space above the appliance. **Do not** place anything on top of the appliance.
 - **Do not** use the appliance for any purpose other than described in this manual.
 - **Do not** let the appliance operate unattended.
 - During hot air frying, hot steam is released through the air exhaust openings. Keep your hands and face at a safe distance from the steam and

from the air exhaust openings. Also be careful of hot steam and hot air when you remove the frying tray from the appliance.

- The surface below the appliance may become hot during use.
- Immediately unplug the appliance if you see dark smoke coming out of the appliance. Wait for the smoke emission to stop before you remove the frying tray from the appliance.

 **Caution**

- Place the appliance on a horizontal, level and stable surface.
- This appliance is intended for normal household use only. It is not intended for use in environments such as staff kitchens, offices, farms or other work environments. Nor is it intended to be used by clients in hotels or other similar environments.
- If the appliance is used improperly or if it is not used according to the instructions in the user manual, the warranty becomes invalid and seller refuses any liability for any damage that may be caused.
- **Always unplug the appliance after use.**
- Let the appliance cool down for approx. 30 minutes before you handle or clean it.
- Remove burnt remnants

	Indicates to read and review instructions to understand operation and use of product.
	Indicates the presence of a hazard that can cause personal injury, death or substantial property damage if the warning included with this symbol is ignored.
	Take care to avoid contact with hot surface. Always use hand protection to avoid burns.



For indoor and household use only.

SAVE THESE INSTRUCTIONS

GETTING TO KNOW YOUR DUALCHEF

A & D: Non-Stick crisper plates

B & E: Cooking Baskets

C & F: Basket handle

G: Top cover

H: Control panel

I: Vent windows

J: Power cord

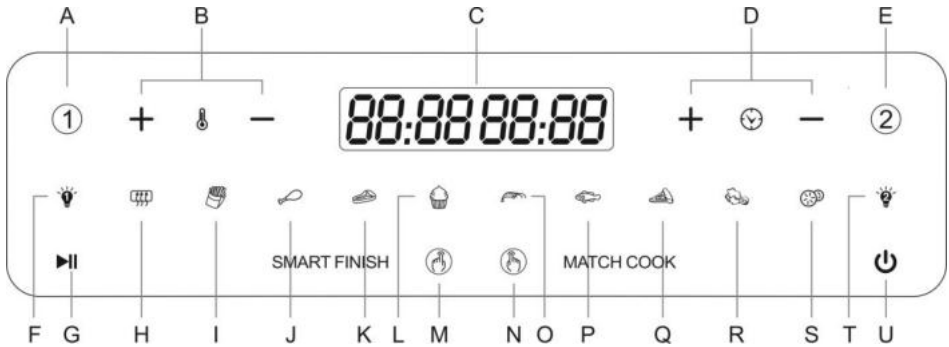
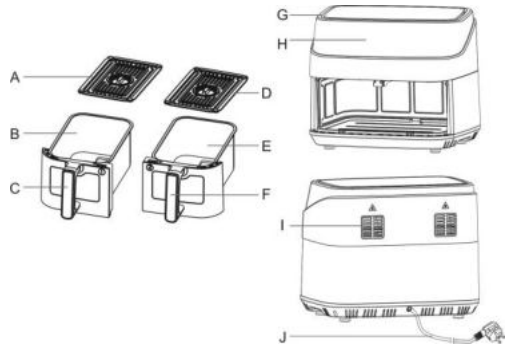

A) Zone 1

B) Temperature plus/minus

C) Timer/temperature

D) Timer plus/minus

E) Zone 2

F) Zone 1 Light

G) Pause

H) Preheat

I) French Fries

J) Drumsticks

K) Steak

L) Cake

-
- M)** Smart Finish
 - N)** Match Cook
 - O)** Shrimp
 - P)** Fish
 - Q)** Pizza
 - R)** Vegetables
 - S)** Dehydrate
 - T)** Zone 2 Light
 - U)** Start/Stop

Before first use

1. Remove all packing material.
2. Remove any stickers or labels from the appliance – other than the rating label.
3. Wash the baskets and crisper plates in hot, soapy water, then rinse and dry thoroughly. The crisper plates and baskets are the ONLY dishwasher-safe parts. Do not clean the main unit in the dishwasher.
4. Wipe the inside and outside of the appliance with a moist cloth.

Preparing for use

1. Place the appliance on a stable, horizontal and level surface that is also heat resistant.
2. Place the basket in the frying tray properly.

Do not fill the frying tray with oil or any other liquid.

Do not put anything on top of the appliance. This disrupts the airflow and affects the air-frying result.



Using the appliance

1. Power on

Plug in, there is BEEPS sounds. Light up. 1 **second** will be back to standby mode: all light will be off expecting .

2. Menu selection/Temperature/Time

1). Plug in, it is at the standby mode. Press , Then press  and select cooking function. you can adjust the time and temperature freely by using Time +/- and Temperature +/- button. You can also press any function icon to cook different food.

2). After finish  function, press  and select cooking function. you can adjust the time and temperature freely by using Time +/- and Temperature +/- button. You can also press any function icon to cook different food.



3). After finish above program then press  unit start to work. Every function has its own default time and temperature (As shown in the table). Customer can adjust the time and temperature freely by using Time +/- and Temperature +/- button.



The temperature control range is 50-200°C, every click on the + / - temperature will

increase or reduce 10°C. At 200°C, press the "+", will loop back to a temperature of 50°C, press the "-" at 50°C temperature will cycle back to 200°C. In the process of temperature control, temperature digital display will flicker on the screen (not flashing during working), after flickering 3 times, the temperature has been done of setting;

The adjusting time range is 1 to 60 mins. every click on the + / - time will increase or reduce 1 min. At 60 min if you press "+", the time will cycle back to 01 min., At 01 min, if you press "-", the temperature will cycle back to 60 min. In the process of time control, time digital display will flicker on the screen (not flashing during working), after flickering 3 times, the time has been done of setting.

3. Start, pause/stop

After select function, set the right time and right temperature, press  , the  start to flicker, after BEEPS sounds, machine start to work.

During the machine working, press  , after BEEPS sounds, machine stop working, 

stop flickering. during the machine working, press  , after BEEPS, machine stop working, and machine back to standby mode.

Noted:

(1). During working, you can take frying tray out, stop working, and you can check cooking result or add more food, machine continue to work on the program if pull in the frying tray.

(2). Power cut or unplug during working, machine stop working, all light off, machine continue to work on the program when power on or plug in again.

3, during work, six red lights for heating element. When red six red lights flicker **one** by one, it means heating element is working, when the temperature reach setting temperature, heating element stop working, and six red lights don't flicker.

4. End of program

Heating element stop working when working time was done, show 00 min, motor continues to work, buzzer warning. motor continues to work 1 min, cooling machine, then machine enter the standby mode.

Smart Finish

SMART FINISH



MATCH COOK

Cooking 2 foods using 2 different functions, temps or cook times?

Problem each zone and use SMART SET to have both zones finish at the same time.

Step1: Program Zone1

Place food in basket, press  Select a cooking function

Step2: Program Zone2

Place food in basket, Press  Select a cooking function

Step3: Begin cooking

Select Smart Finish, press  to begin cooking

Match Cook

SMART FINISH



MATCH COOK

Cooking the same food in each zone?

Set Zone 1 and use MATCH COOK to automatically match settings to zone 2.

Step1: program Zone1











Place food in basket, Press  Select a cooking function

Step2: Begin cooking

Select MATCH COOK, press  to begin cooking.

Menu Table

program logistics

	menu	Default time(min)	Default temperature (°C)
Function	 Pre-heat	3	180
	 French Fries	15	200
	 Drumsticks	20	200
	 Steak	12	180
	 Cake	25	160
	 Shrimp	8	180
	 Fish	10	180
	 Pizza	20	180
	 Vegetable	10	160
	 Dehydrate	360	60

Caution: Do not touch the pan during and about 30mins after use, as it gets very hot. Only hold the pan by the handle.

Operation Step

1. Put the mains plug in an earthed wall socket.
2. Put the ingredients into the basket and put basket in frying tray

3. put the frying tray in the right position. Choose function from menu and press START/PAUSE to start/stop cooking.

4. Screen display will show temperature and time. Temperature is the setting temperature and time is remaining working time

The function we have selected is flicker

5. Some ingredients require shaking halfway through the preparation time (see section 'Settings' in this chapter). To shake the ingredients, pull the frying tray out of the appliance by the handle and shake it. Then slide the frying tray back into the air fryer.

Caution: Do not press the basket release button during shaking.

6. When you hear the timer bell, the set preparation time has elapsed. Pull the pan out of the appliance and place it on a heat-resistant surface.

7. Check if the ingredients are ready.

If the ingredients are not ready yet, simply slide the frying tray back into the appliance and cook it extra minutes

Tip: To reduce the weight, you can remove the basket from the pan and shake the basket only. To do so, pull the pan out of the appliance, place it on a heat-resistant surface and press the basket release button.

8. To remove small ingredients, press the basket release button and lift the basket out of the frying tray.

Do not turn the basket upside down with the frying tray still attached to it, as any excess oil that has collected on the bottom of the frying tray will spill out and leak onto the ingredients.

After hot air frying, the frying tray and the ingredients are hot. Depending on the type of ingredients in the air fryer, steam may escape form the frying tray.

9. Empty the basket into a bowl or onto a plate.

Tip: To remove large or fragile ingredients, use a pair of tongs to lift the ingredients out of the basket.

10. When a batch of ingredients is ready, the air fryer is instantly ready for preparing another batch.

Note: When using the Health Fryer for the first time, a slight smoke or odour may be emitted. This is normal and will soon subside. Ensure that there is sufficient ventilation around the Health Fryer.

Settings

Except the preset menu, you also can use this air fryer to make other foods by setting the time and temperature. This table below helps you to select the basic settings for the

ingredients you want to prepare.

Note: *Keep in mind that these settings are only for reference. As ingredients differ in origin, size, shape as well as brand, we cannot guarantee the best setting for your ingredients.*

Because the Rapid Air Technology instantly reheats the air inside the appliance, pulling the frying tray briefly out of the appliance during hot air frying barely disturbs process.

Tips:

- Smaller ingredients usually require a slightly shorter preparation time than larger ingredients.
- A larger amount of ingredients only requires a slightly longer preparation time; a smaller amount of ingredients only requires a slightly shorter preparation time.
- Shaking smaller ingredients halfway through the preparation time optimized the end result and can help prevent unevenly fried ingredients.
- You can coat fresh potatoes with a little oil for a crispy result. Fry your ingredients in the air fryer within a few minutes after you have added the oil.
- Do not prepare extremely greasy ingredients such as sausages in the air fryer.
- Snacks that can be prepared in an oven can also be prepared in the air fryer.
- The optimal amount for preparing crispy fries is 500 grams.
- Use pre-made dough to prepare filled snacks quickly and easily. Pre-made dough also requires a shorter preparation time than home-made dough.
- You can also use the air fryer to reheat ingredients by setting the temperature to 150°C and the timer to about 10 minutes.

	Time (min.)	Temperature (°C)	Shake	Extra information
--	----------------	---------------------	-------	-------------------

Potatoes & fries

Thin frozen fries	12-16	200	Shake	
Thick frozen fries	12-20	200	Shake	
Home-made fries (8x8mm)	18-25	180	Shake	add 1/2 tbsp of oil
Home-made potato wedges	18-22	180	Shake	add 1/2 tbsp of oil
Home-made potato cubes	12-18	200	Shake	add 1/2 tbsp of oil
Rösti	15-18	180		
Potato gratin	18-22	180		

Meat & Poultry

Steak	8-12	180		
Pork chops	10-14	180		
Hamburger	7-14	180		
Sausage roll	13-15	200		
Drumsticks	18-22	180		
Chicken breast	10-15	180		

Snacks

Spring rolls	8-10	200	Shake	Use oven-ready
Frozen chicken Nuggets	6-10	200	Shake	Use oven-ready
Frozen fish fingers	6-10	200		Use oven-ready
Frozen Bread-crumbed cheese snacks	10	200		Use oven-ready
Stuffed vegetables	10	160		Use oven-ready

Note: Add 3 minutes to the preparation time before you start frying if the appliance is cold.

Making home-made fries

For the best results, we advise to use pre-baked fries. If you want to make home-made fries, follow the steps below:

1. Peel the potatoes and cut them into sticks.
2. Soak the potato sticks in a bowl of water for at least 30 minutes, take them out and dry them with kitchen paper.
3. Pour 1/2 tablespoon of olive oil in a bowl, put the sticks on top and mix until the sticks are coated with oil.
4. Remove the sticks from the bowl with your fingers or a kitchen utensil so that excess oil stays behind in the bowl. Put the sticks in the basket.

Note: *Do not tilt the bowl to put all the sticks in the basket in one go, to prevent excess oil from collecting at the bottom of the frying tray.*

5. Fry the potato sticks according to the instructions in this chapter.

Cleaning

Clean the appliance after every use.

The frying tray, basket and the inside of the appliance have a non-stick coating. Do not use metal kitchen utensils or abrasive cleaning materials to clean them, as this may damage the non-stick coating.

1. Remove the mains plug from the wall socket and let the appliance cool down.

Note: *Remove the frying tray to let the air fryer cool down more quickly.*

2. Wipe the outside of the appliance with a moist cloth.
3. Clean the frying tray and basket with hot water, some washing liquid soap and a non-abrasive sponge.

You can use a washing liquid to remove any remaining dirt.

Note: *The frying tray and basket are dishwasher-proof.*

Tip: If dirt is stuck to the basket, or at the bottom of the frying tray, fill the frying tray with hot water and with some washing liquid soap. Put the basket in the frying tray and let the frying tray and the basket soak for approximately 10 minutes.

1. Clean the inside of the appliance with hot water and a non-abrasive sponge.
2. Clean the heating element with a cleaning brush to remove any food residues.

Storage

-
1. Unplug the appliance and let it cool down.
 2. Make sure all parts are clean and dry.



Disposal of old electrical appliances

The European directive 2002/96/EC on Waste Electrical and Electronic Equipment (WEEE), requires that old household electrical appliances must not be disposed of in the normal unsorted municipal waste stream.

Old appliances must be collected separately in order to optimize the recovery and recycling of the materials they contain, and reduce the

impact on human health and the environment.

The crossed out “wheeled bin” symbol on the product reminds you of your obligation, that when you dispose of the appliance, it must be separately collected.

Consumers should contact their local authority or retailer for information concerning the correct disposal of their old appliance.

Troubleshooting

Problem	Possible cause	Solution
The air fryer does not work	The appliance is not plugged into the mains.	Put the mains plug in an earthed wall socket.
	You have not set the timer.	Turn the timer knob to the required Preparation time to switch on the appliance.
The ingredients fried with the air fryer are not done.	The amount of the ingredients in the basket is too much.	Put smaller batches of ingredients in the basket. Smaller batches are fried more evenly.
	The set temperature is too low.	Turn the temperature control knob to the required temperature setting (see section 'Settings').
	The preparation time is too short.	Turn the timer knob to the required preparation time (see section 'Settings').
The ingredients are fried unevenly in the air fryer.	Certain types of the ingredients need to be shaken halfway through the preparation time.	Ingredients that lie on top of or across each other (e.g. fries) need to be shaken halfway through the preparation time (see section 'Settings').
Fried snacks are not crispy when they come out of the air fryer	You used a type of snacks meant to be prepared in a traditional deep fryer.	Use oven snacks or lightly brush some oil onto the snacks for a crispier result.
I cannot slide the pan into the appliance properly.	There is too much food in the basket.	Do not fill the basket beyond the Max amount indicated in the table on the earlier page.
	The basket is not placed in the pan correctly.	Push the basket down into the pan until you hear a click.
White smoke comes out of the appliance	You are preparing greasy ingredients.	Pay attention that the temperature is well-controlled to be under 180°C, when you fry greasy ingredients in the air fryer.

Problem	Possible cause	Solution
	The pan still contains greasy residues from previous use.	White smoke is caused by grease heating up in the pan. Make sure you clean the pan properly after each use.
Fresh potato fries are fried unevenly in the air fryer.	You did not soak the potato sticks properly before you fried them.	Soak the potato sticks in a bowl of water for at least 30 minutes; take them out and dry them with kitchen paper.
	You did not use the right potato type.	Use fresh potatoes and make sure they stay firm during frying.
Fresh potato fries are not crispy when they come out of the air fryer.	The crispiness of the fries depends on the amount of oil and water in the fries.	Make sure you dry the potato sticks properly before you coat them with oil.
		Cut the potato into thinner sticks for a crispier result.
		Add slightly more oil for a crispier result.

LIMITED WARRANTY

Limited Warranty applies to purchases made from authorized retailers of **TurboTronic®**.

TurboTronic® Warranty coverage applies to the original owner and to the original product only and is not transferable.

TurboTronic® warrants that the unit shall be free from defects in material and workmanship. Limited Warranty apply only when it is used under normal household conditions and maintained according to the requirements outlined in the Owner's Guide, subject to the following conditions and exclusions:

What is covered by this warranty?

1. The original unit and/or non-wearable parts deemed defective, in **TurboTronic®** sole discretion, will be repaired or replaced

2. **TurboTronic®** reserves the right to replace the unit with one of equal or greater value.

What is not covered by this warranty?

1. Normal wear and tear of wearable parts (such as blending vessels, lids, cups, blades, blender bases, removable pots, racks, pans, etc.), which require regular maintenance and/or replacement to ensure the proper functioning of your unit, are not covered by this warranty.
2. Any unit that has been tampered with or used for commercial purposes.
3. Damage caused by misuse, abuse, negligent handling, failure to perform required maintenance (e.g., failure to keep the well of the motor base clear of food spills and other debris), or damage due to mishandling in transit.
4. Consequential and incidental damages.
5. Defects caused by repair persons not authorized by **TurboTronic®**. These defects include damages caused in the process of shipping, altering, or repairing the **TurboTronic®** product (or any of its parts) when the repair is performed by a repair person not authorized by **TurboTronic®**.
6. Products purchased, used, or operated outside Europe.

Illustrations may differ from actual product.

We are constantly striving to improve our products, therefore the specifications contained herein are subject to change without notice.

TurboTronic® and **Z-Line®** are registered trademarks of **Z-GLOBAL B.V.B.A®**.
PRINTED IN PRC